

# BRIEDŽIO UŽDUOTYS

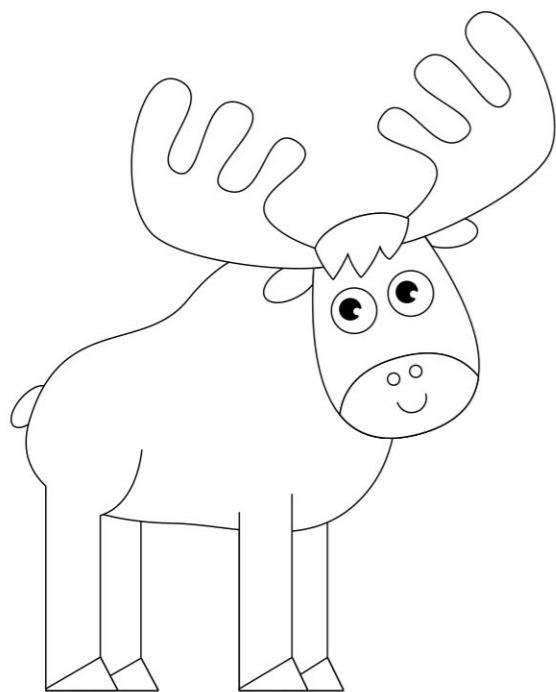

1. SUJUNK TAŠKUS.

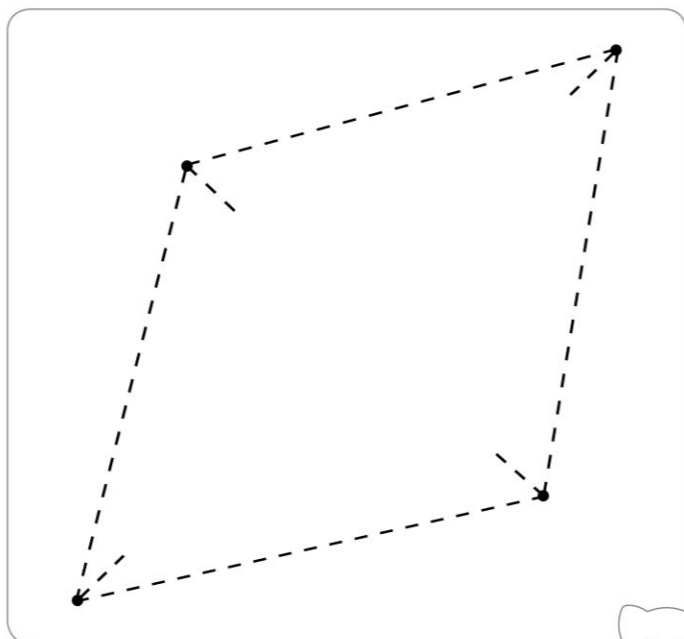

2. SUJUNK VIENODUS LAPELIUS IR NUSPALVINK TA PAČIA SPALVA.

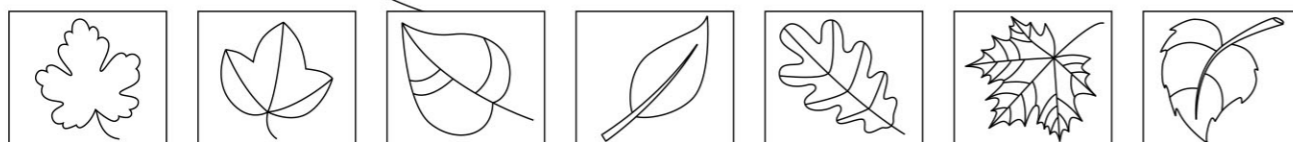
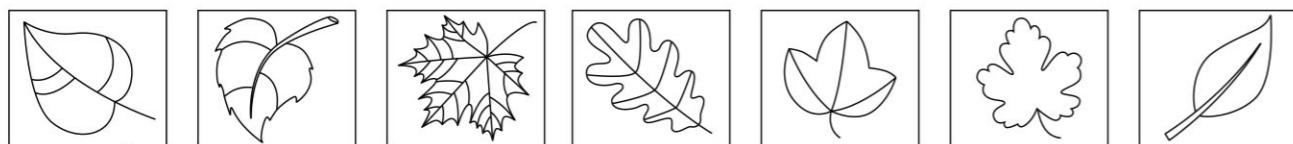

3. PRATĘSK LINIJĄ.

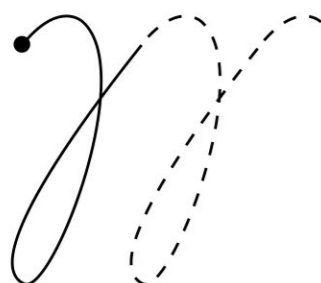

4. APVEDŽIOK IR PIEŠK, KAIP PRADĖTA.

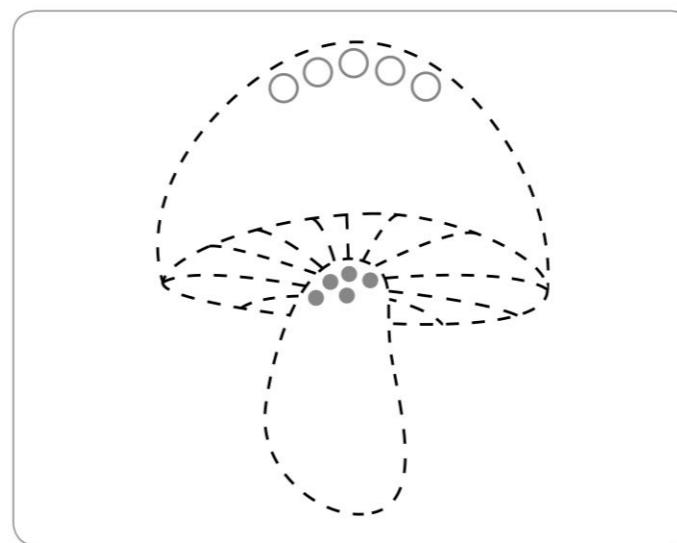

6. SUJUNK TAŠKUS.

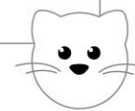
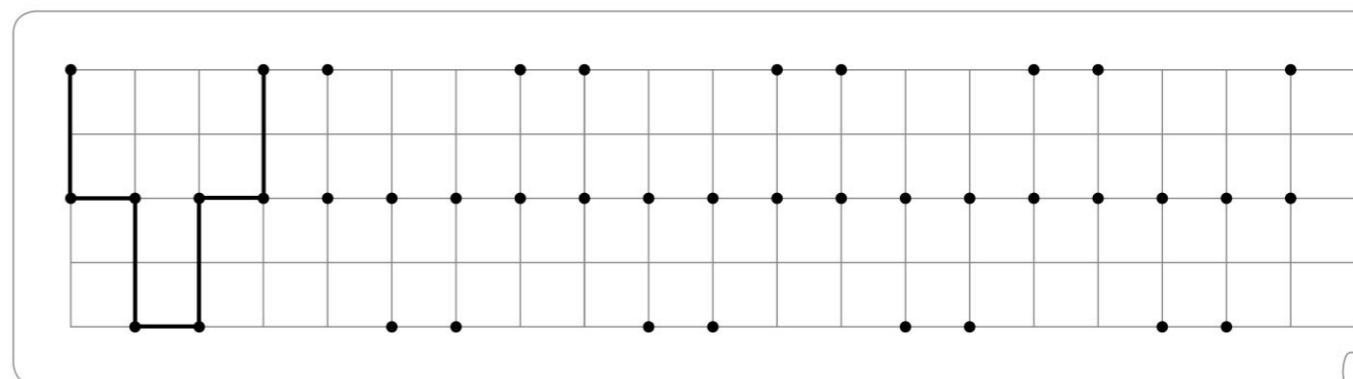

5. APVEDŽIOK IR BRĖŽK LINIJAS, KAIP PARODYTA.

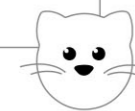
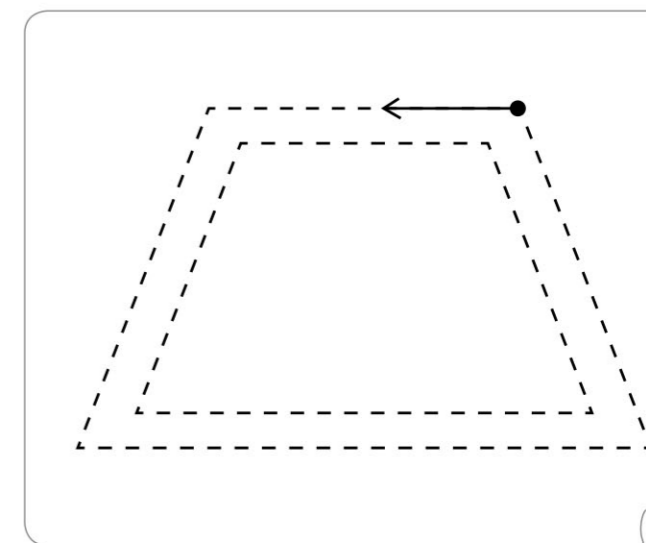

7. BRĖŽK NEPAKELDAMAS RANKOS.

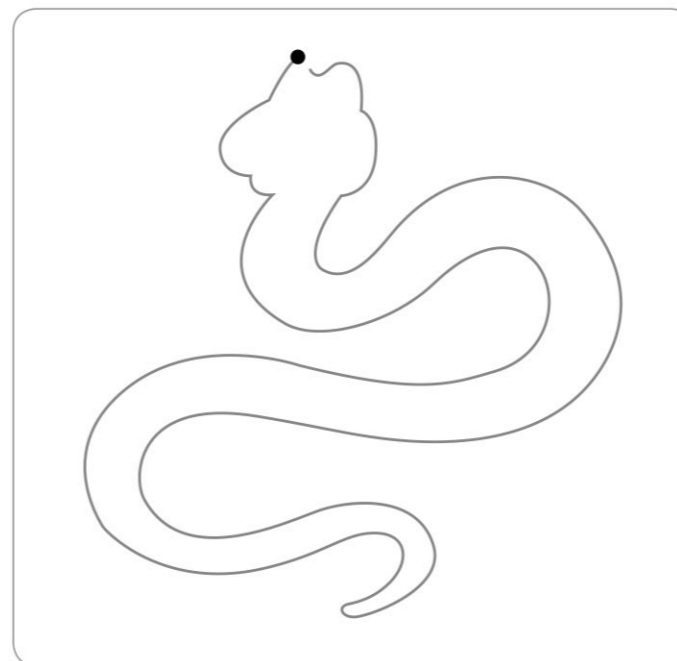

8. SUKURK PIEŠINĖLĮ.

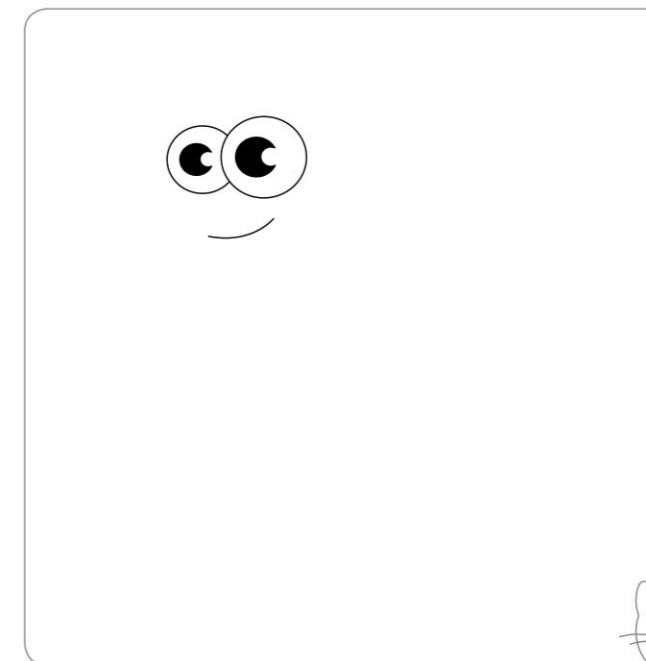

9. BAIK PIEŠINĒĻ.

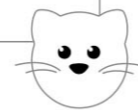
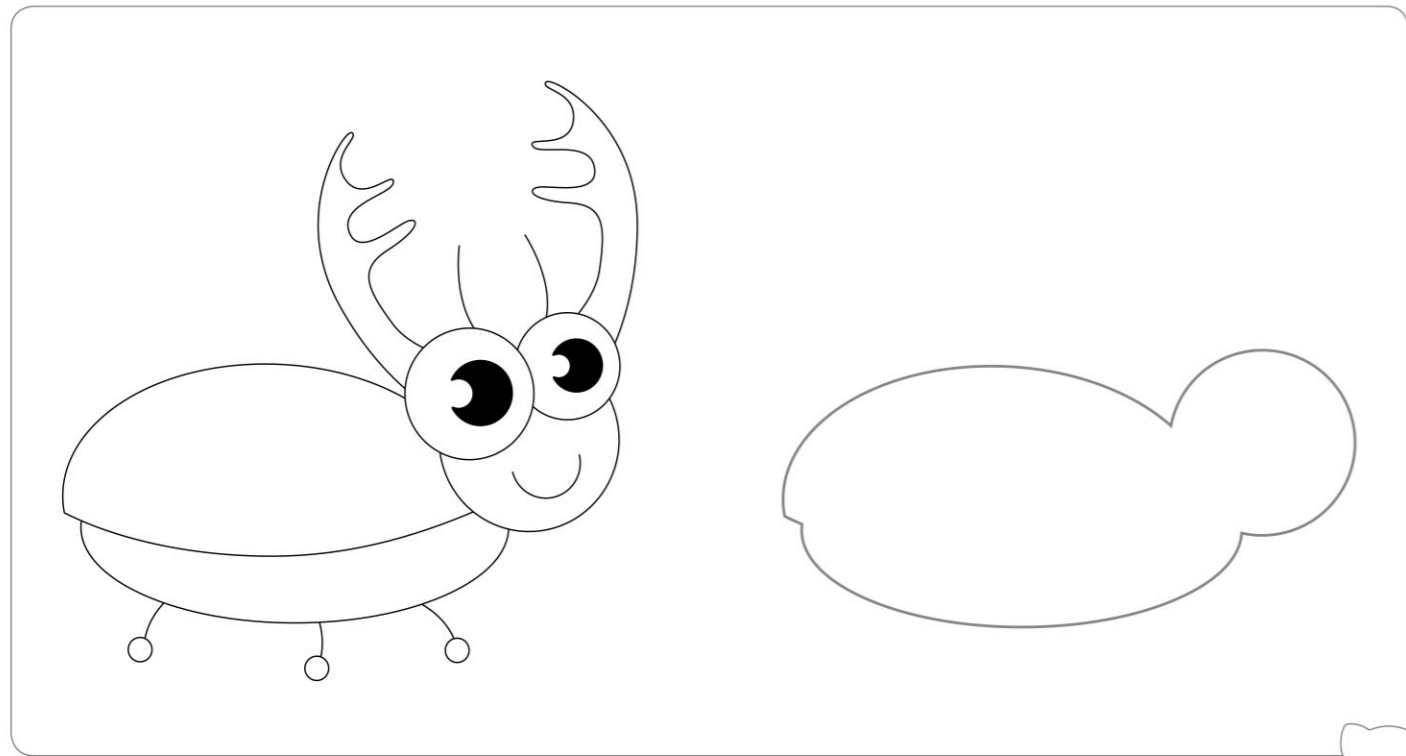

10. SUJUNK TAŠKUS.

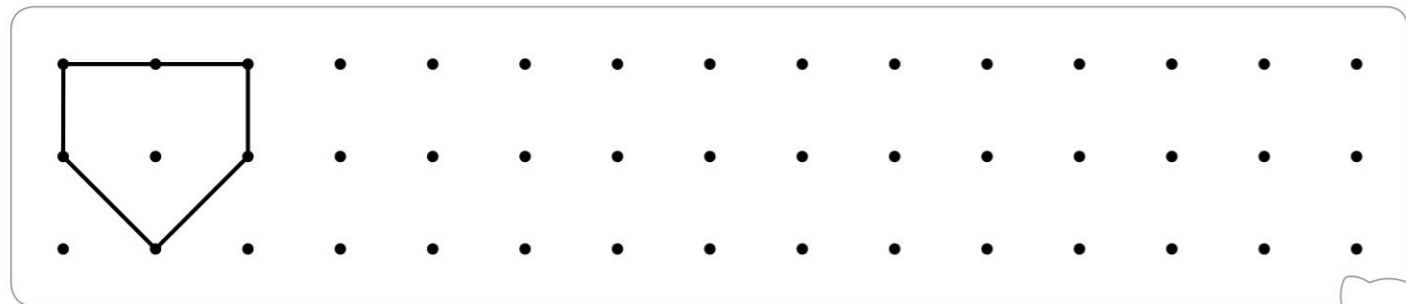

11. UŽBRŪKŠNIUOK.

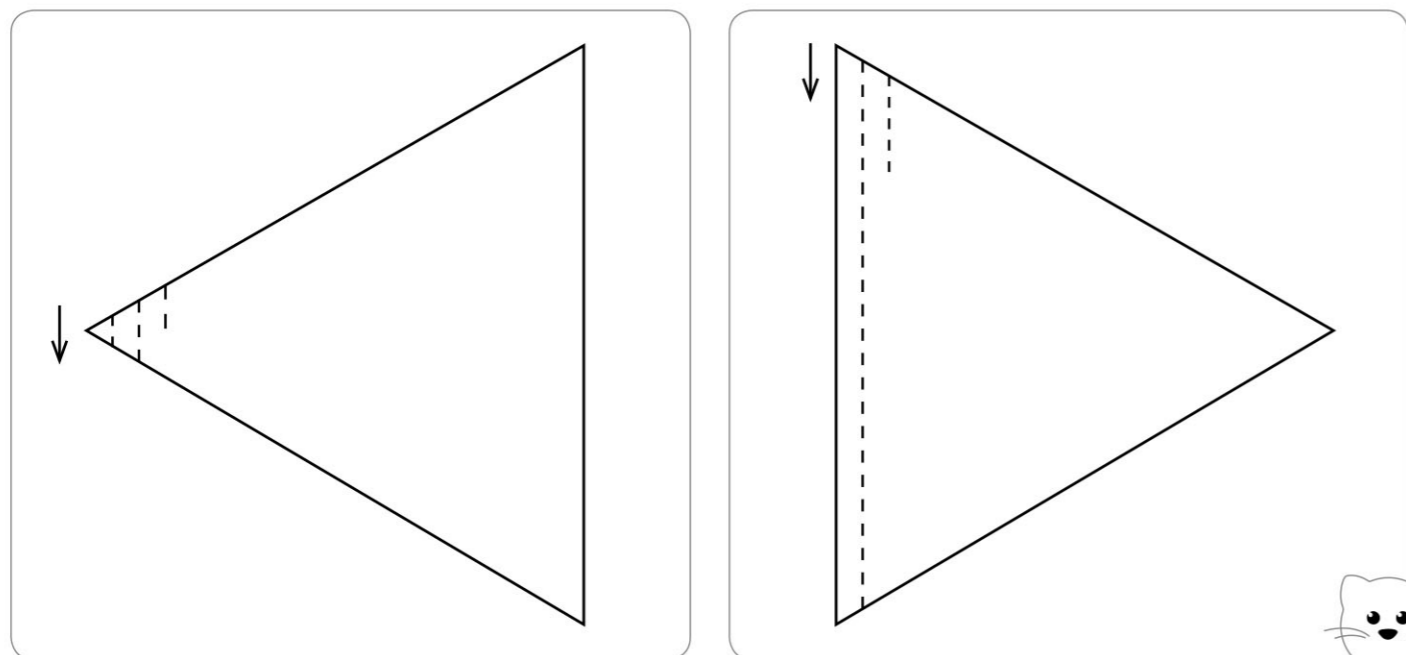

12. NUPIEŠK KITĀ PUSĒ. NUSPALVINK PIEŠINĒLIUS.

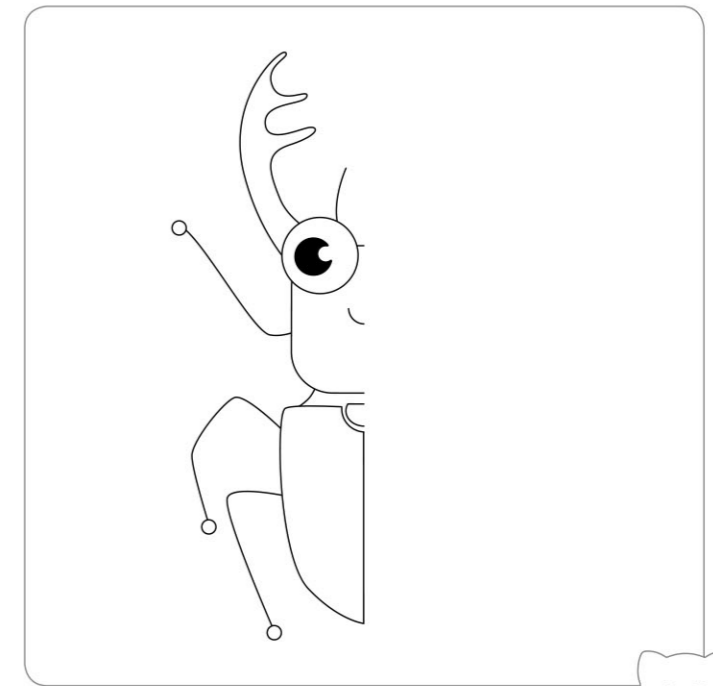
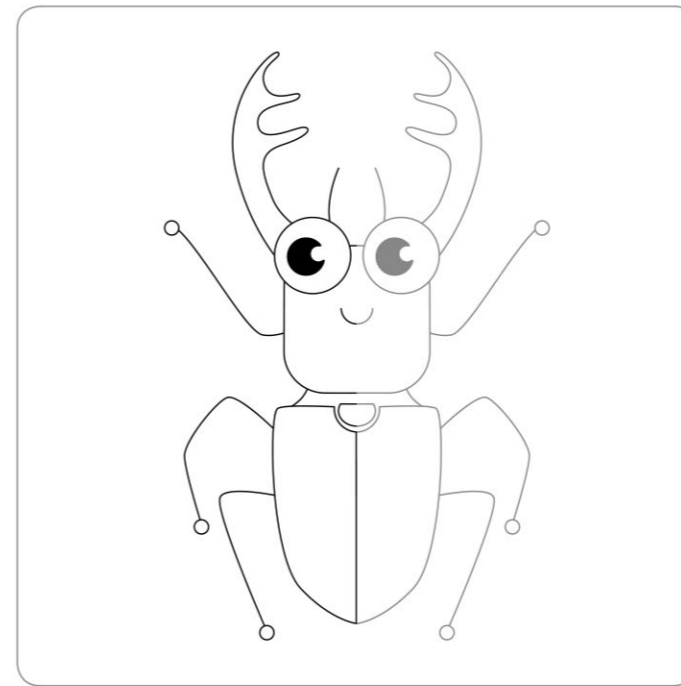

13. NUPIEŠK TAIP PAT. NUSPALVINK.

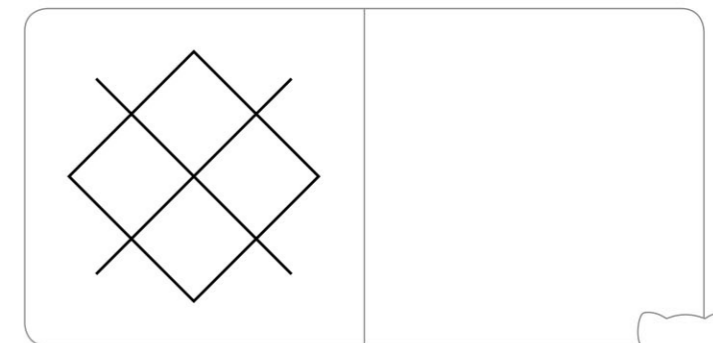
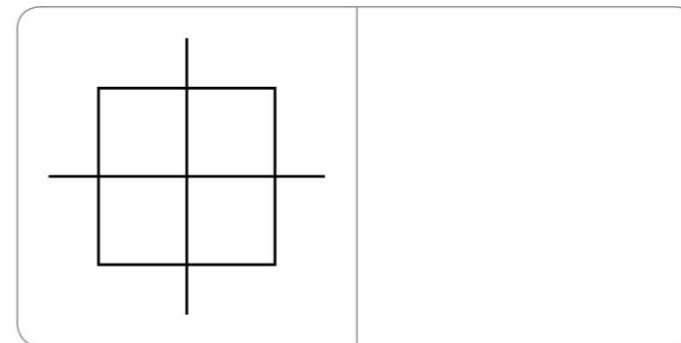

14. NUPIEŠK TOKĻ PAT PIEŠINĒĻ. NUSPALVINK JĻ.

